





Fast Response Measurement System

-  Additive manufacturing allows almost any geometry
-  Titanium, Inconel, stainless steel, plastics
-  Robust design
-  Adjustable reference surfaces, connection, and software
-  Measurement frequencies up to 5 kHz

Fast response multi-hole probe

Geometry	Straight, L-shaped, Cobra, Drilled elbow
Number of holes	4HP, 5HP, Custom
Max. length	Custom
Min. tip diameter	Standard 3-4 mm
Shaft diameter	12.7 mm minimum
Tip geometry	Conical, spherical or custom
Material	Stainless steel, Titanium, Inconel, Plastics
Fixture	Square, Hexagonal, one-sided flattened cylinder or custom
Pressure sensors	Custom. Range 1, 2, 5, 10, 15 PSI. Low noise Piezo resistive sensors. Excitation Voltage: 10 Vdc recommended
Connector	LEMO Type or custom
Acquisition Hardware	1x NI 9237 & 1x cDAQ 9181 (Chassis) or custom
Acquisition and post-processing software	VectoVis Professional or LabVIEW DLL
Temperature range	70°C (higher with water cooling)
Angle range	±45° (4HP), ±60° (5HP)
Angle accuracy	< ±1°
Velocity range	10 m/s to Mach 1
Velocity accuracy	< ±1 m/s



The unsteady probes from Vectoflow make it possible to detect high-frequency flow phenomena in the kHz range not just in terms of one measured quantity, but also related to all quantities available from conventional multi-hole probes: 3D velocities, flow angles, total and static pressure, Mach number, and density. This makes it the ideal choice for measurements of:

- 3D turbulence spectra
- Time-resolved high frequency measurements
- Shock events
- Unsteady aerodynamics of rotating systems
- CFD Validation
- Aero-acoustic phenomena

In order to achieve this high temporal resolution, the pressure sensors must be as close as possible to the probe head. This is to minimize the modulation of the pressure fluctuations in amplitude and phase. Furthermore, this

modulation must be determined experimentally, which is done at Vectoflow with a specially developed frequency calibration rig.

In many cases, either damping (thin tubes) or excitation (wider tubes) will occur even for frequencies of 10 Hz and above. A frequency response calculation and calibration is then needed to measure data of time series or spectra. With our simulation tool, we can optimize the internal geometry to get the best compromise between spatial and temporal resolution.

Vectoflow offers the following solutions for the measurement of unsteady flow phenomena:

- Probes with embedded pressure sensors (higher frequency response) or conventional probes with separated pressure sensors
- Frequency calibration of each pressure channel

All the advantages of the Vectoflow steady probes, such as the flexibility in geometry and increased robustness of the probes, are also available to the customers for the unsteady probes due to the optimized additive manufacturing process.

System Solutions

Vectoflow provides complete system solutions for velocity measurements for different flow conditions.

The Fast Response Measurement System includes:

- Fast response probe
- Cabling and connection
- cDAQ System
- Post-processing software
- Calibration data
- Consulting for data evaluation



Frequency Calibration

The frequency response depends on the acoustic behavior of the pressure line and the dynamic behavior of the sensor. This will be determined in an acoustic chamber, which will compare the dynamic behavior of the probe to a known reference. The resulting transfer functions are used to correct the pressure signals.

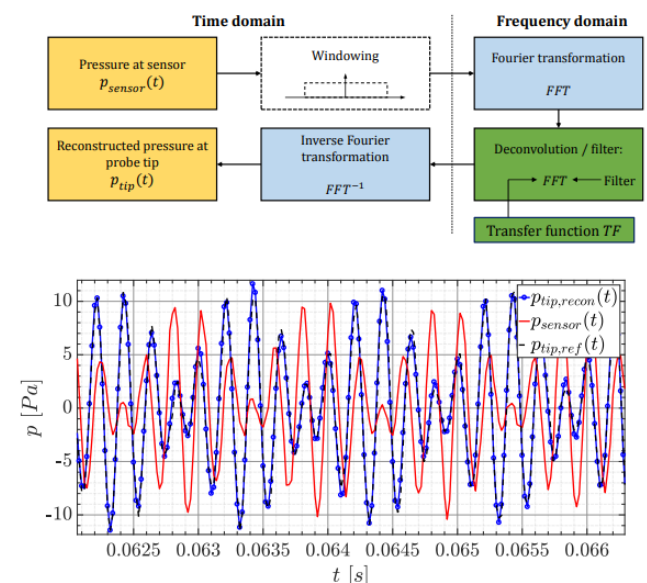

Calibration system	Acoustic calibration
---------------------------	----------------------

Frequency range	< 5 kHz (depending on probe geometry)
------------------------	---------------------------------------

Transfer function frequency step size	Custom
--	--------

Sensors

Dependent on the required velocity range. Kulite & Endevco miniature differential pressure sensors are used.

Pressure range (psig)	1, 2, 5, 10, 15
Supply voltage	[0 - 18 V] (10 Vdc recommended)
Full scale output	300 ±100 mV at 10 Vdc
Sensor accuracy	1.5 % FS Pressure Hysteresis, 3 % FS Thermal Zero Shift, 4 % Thermal Sensitivity Shift
Reference	Reference surface normal to Z-axis
Compensation possible	Over a 93°C span, from -54°C to 107°C on special order

Measurement Error

The measurement error of a multi-hole probe depends on the pressure sensor or scanner used for the calibration and data acquisition.

We recommend the use of pressure sensors whose pressure range covers just the expected dynamic pressure, and which can be as good as 0.1% full-scale (FS) or even better at lower frequencies.

On-demand miniature pressure sensors can be calibrated over a temperature range to decrease thermal drift and nonlinearity, which can be the main source of uncertainty for this type of sensors.

The lower the velocity, the higher the impact of the pressure measurement error onto the determination of the flow velocity, as shown in Figure 1 (for a scanner accuracy of ± 0.05% FS).

Generally, an error of 1 m/s or 1% of the measured velocity — whichever is higher — is expected at higher speeds. For lower speeds, the

error depends on the pressure scanner, and increases the lower the speed.

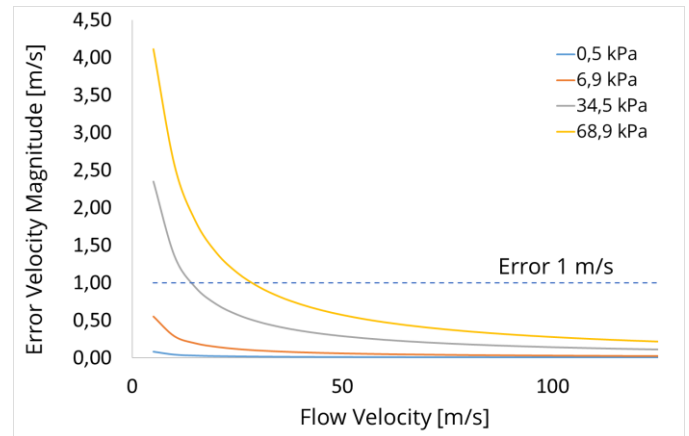

Figure 1: Dependence of velocity measurement error on pressure scanner range (0.05% FS accuracy)

Angle Calibration Process

The calibration process is always necessary for manufactured multi-hole probes. Vectoflow has its own calibration wind tunnel, delivering flow speeds from 1 m/s up to Mach 1.4. Vectoflow has a very rigid quality assurance, which ultimately leads to the highest possible measurement accuracy of the flow probes.

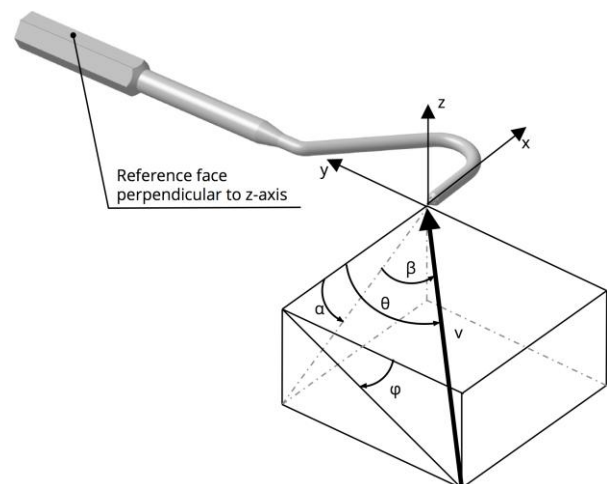

Figure 2: Flow angle definitions

During the calibration process, the probe is exposed to a steady flow with known conditions,

while pitch and yaw angles change through thousands of positions. The definition of the flow angles is shown in Figure 2.

The following table shows the main characteristics of the Vectoflow calibration wind tunnel:

Calibration wind tunnel	
Angular range	$\pm 165^\circ$ (yaw axis), 180° (roll axis)
Max. Power	90 kW
Velocity range	From 1 m/s to Mach 1.4
Control parameters	Mach number, velocity (m/s)
Long-term velocity stability	$\pm 0.25\%$ (at M 0.1)

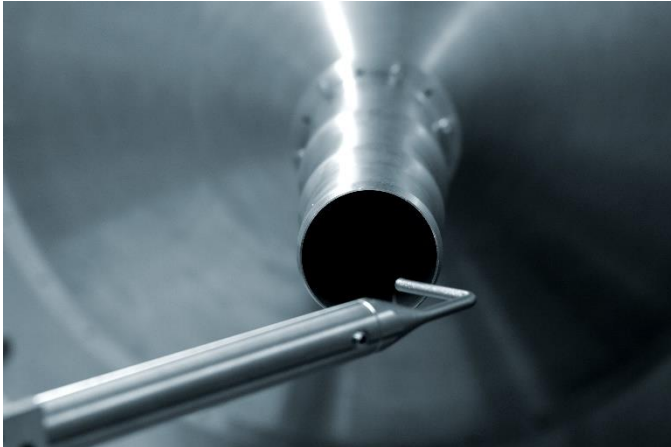

Contact

Vectoflow GmbH, Germany

T: +49 89 124149570

M: info@vectoflow.de

w: www.vectoflow.de